

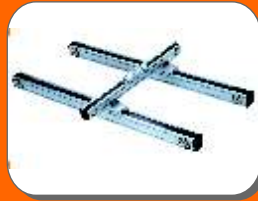

ACTUATORS, X-Y TABLE



LINEAR GUIDEWAY & LM BEARING



BALL SCREW, COUPLING, TIMING BELT & PULLEY



MOTION & CONTROL



ROTARY INDEXING TABLE



ROBOFLEX CHAIN



BEARINGS & BUSHES



AL PROFILE & ACCESSORIES





INDUSTRIAL SYNCHRONOUS BELTS

POWERGRIP® HTD® BELT SIZES

3M Pitch: 3 mm

Pitch and length designation	Pitch length mm	Number of teeth
105-3M	105	35
111-3M	111	37
120-3M	120	40
123-3M	123	41
126-3M	126	42
129-3M	129	43
141-3M	141	47
144-3M	144	48
150-3M	150	50
156-3M	156	52
159-3M	159	53
165-3M	165	55
168-3M	168	56
171-3M	171	57
174-3M	174	58
177-3M	177	59
180-3M	180	60
183-3M	183	61
186-3M	186	62
189-3M	189	63
192-3M	192	64
195-3M	195	65
201-3M	201	67
204-3M	204	68
210-3M	210	70
213-3M	213	71
216-3M	216	72
219-3M	219	73
222-3M	222	74
225-3M	225	75
234-3M	234	78
237-3M	237	79
243-3M	243	81
246-3M	246	82
249-3M	249	83
252-3M	252	84
255-3M	255	85
267-3M	267	89
276-3M	276	92
282-3M	282	94
285-3M	285	95
288-3M	288	96
291-3M	291	97
294-3M	294	98
297-3M	297	99
300-3M	300	100
306-3M	306	102
312-3M	312	104
315-3M	315	105

3M Pitch: 3 mm

Pitch and length designation	Pitch length mm	Number of teeth
318-3M	318	106
330-3M	330	110
333-3M	333	111
336-3M	336	112
339-3M	339	113
342-3M	342	114
345-3M	345	115
357-3M	357	119
363-3M	363	121
372-3M	372	124
381-3M	381	127
384-3M	384	128
393-3M	393	131
420-3M	420	140
435-3M	435	145
447-3M	447	149
462-3M	462	154
474-3M	474	158
477-3M	477	159
480-3M	480	160
486-3M	486	162
501-3M	501	167
513-3M	513	171
522-3M	522	174
525-3M	525	175
531-3M	531	177
537-3M	537	179
552-3M	552	184
558-3M	558	186
564-3M	564	188
570-3M	570	190
573-3M	573	191
582-3M	582	194
591-3M	591	197
594-3M	594	198
600-3M	600	200
612-3M	612	204
627-3M	627	209
633-3M	633	211
645-3M	645	215
648-3M	648	216
669-3M	669	223
672-3M	672	224
681-3M	681	227
711-3M	711	237
720-3M	720	240
735-3M	735	245
738-3M	738	246

3M Pitch: 3 mm

Pitch and length designation	Pitch length mm	Number of teeth
753-3M	753	251
804-3M	804	268
822-3M	822	274
882-3M	882	294
945-3M	945	315
981-3M	981	327
1002-3M	1002	334
1071-3M	1071	357
1080-3M	1080	360
1176-3M	1176	392
1245-3M	1245	415
1263-3M	1263	421
1500-3M	1500	500
1530-3M	1530	510
1863-3M	1863	621
1926-3M	1926	642

Available in widths of 6 mm, 9mm and 15 mm.

5M Pitch: 5 mm

Pitch and length designation	Pitch length mm	Number of teeth
120-5M	120	24
225-5M	225	45
255-5M	255	51
265-5M	265	53
270-5M	270	54
275-5M	275	55
280-5M	280	56
295-5M	295	59
300-5M	300	60
305-5M	305	61
325-5M	325	65
330-5M	330	66
335-5M	335	67
340-5M	340	68
345-5M	345	69
350-5M	350	70
360-5M	360	72
365-5M	365	73
370-5M	370	74
375-5M	375	75
385-5M	385	77

Preferred sizes are printed in bold.

Regd. Office : 5224, Nigam Market, G.B. Road, Delhi - 110006

Head Office : B-97/4, Naraina Industrial Area, Phase - I, New Delhi - 28 Ph.: 011 - 42709155 / 66 Fax : 011 - 45040209

Branch Office : Door No. 1/9, Rajamannar Salai, Vijayaraghavapuram, K.K. Nagar, Chennai - 600 093 Ph.: 044 - 42669808

Email : info@pbh.in

D-35

Website : www.pbh.in

INDUSTRIAL SYNCHRONOUS BELTS

POWERGRIP® HTD® BELT SIZES

5M Pitch: 5 mm

Pitch and length designation	Pitch length mm	Number of teeth
400-5M	400	80
405-5M	405	81
420-5M	420	84
425-5M	425	85
450-5M	450	90
460-5M	460	92
475-5M	475	95
500-5M	500	100
510-5M	510	102
520-5M	520	104
525-5M	525	105
535-5M	535	107
550-5M	550	110
560-5M	560	112
565-5M	565	113
575-5M	575	115
580-5M	580	116
600-5M	600	120
610-5M	610	122
615-5M	615	123
635-5M	635	127
640-5M	640	128
645-5M	645	129
665-5M	665	133
670-5M	670	134
695-5M	695	139
700-5M	700	140
710-5M	710	142
720-5M	720	144
740-5M	740	148
750-5M	750	150
755-5M	755	151
770-5M	770	154
775-5M	775	155
800-5M	800	160
825-5M	825	165
835-5M	835	167
860-5M	860	172
870-5M	870	174
890-5M	890	178
900-5M	900	180
925-5M	925	185
935-5M	935	187
940-5M	940	188
950-5M	950	190
965-5M	965	193
980-5M	980	196

5M Pitch: 5 mm

Pitch and length designation	Pitch length mm	Number of teeth
1000-5M	1000	200
1025-5M	1025	205
1035-5M	1035	207
1050-5M	1050	210
1100-5M	1100	220
1125-5M	1125	225
1135-5M	1135	227
1175-5M	1175	235
1200-5M	1200	240
1225-5M	1225	245
1270-5M	1270	254
1350-5M	1350	270
1380-5M	1380	276
1420-5M	1420	284
1595-5M	1595	319
1690-5M	1690	338
1790-5M	1790	358
1870-5M	1870	374
2100-5M	2100	420
2350-5M	2350	470

Available in widths of 9 mm, 15 mm and 25 mm.

8M Pitch: 8 mm

Pitch and length designation	Pitch length mm	Number of teeth
264-8M	264	33
320-8M	320	40
376-8M	376	47
384-8M	384	48
424-8M	424	53
480-8M	480	60
512-8M	512	64
520-8M	520	65
560-8M	560	70
576-8M	576	72
600-8M	600	75
608-8M	608	76
624-8M	624	78
640-8M	640	80
656-8M	656	82
720-8M	720	90
760-8M	760	95
776-8M	776	97
800-8M	800	100
856-8M	856	107

8M Pitch: 8 mm

Pitch and length designation	Pitch length mm	Number of teeth
880-8M	880	110
912-8M	912	114
920-8M	920	115
960-8M	960	120
968-8M	968	121
976-8M	976	122
1000-8M	1000	125
1040-8M	1040	130
1064-8M	1064	133
1080-8M	1080	135
1120-8M	1120	140
1128-8M	1128	141
1160-8M	1160	145
1176-8M	1176	147
1200-8M	1200	150
1216-8M	1216	152
1224-8M	1224	153
1256-8M	1256	157
1264-8M	1264	158
1280-8M	1280	160
1304-8M	1304	163
1360-8M	1360	170
1424-8M	1424	178
1432-8M	1432	179
1440-8M	1440	180
1512-8M	1512	189
1520-8M	1520	190
1552-8M	1552	194
1584-8M	1584	198
1600-8M	1600	200
1696-8M	1696	212
1728-8M	1728	216
1760-8M	1760	220
1800-8M	1800	225
1896-8M	1896	237
1904-8M	1904	238
2000-8M	2000	250
2080-8M	2080	260
2200-8M	2200	275
2240-8M	2240	280
2272-8M	2272	284
2400-8M	2400	300
2504-8M	2504	313
2600-8M	2600	325
2800-8M	2800	350

Preferred sizes are printed in bold.

Regd. Office : 5224, Nigam Market, G.B. Road, Delhi - 110006

Head Office : B-97/4, Naraina Industrial Area, Phase - I, New Delhi - 28 Ph.: 011 - 42709155 / 66 Fax : 011 - 45040209

Branch Office : Door No. 1/9, Rajamannar Salai, Vijayaraghavapuram, K.K. Nagar, Chennai - 600 093 Ph.: 044 - 42669808

Email : info@pbh.in

D-36

Website : www.pbh.in



INDUSTRIAL SYNCHRONOUS BELTS

POWERGRIP® GT BELT SIZES

2MR Pitch: 2 mm

Pitch and length designation	Pitch length mm	Number of teeth
2MR-74	74	37
2MR-76	76	48
2MR-80	80	40
2MR-90	90	45
2MR-100	100	50
2MR-112	112	56
2MR-130	130	65
2MR-132	132	66
2MR-134	134	67
2MR-140	140	70
2MR-142	142	71
2MR-152	152	76
2MR-158	158	79
2MR-164	164	82
2MR-168	168	84
2MR-172	172	86
2MR-178	178	89
2MR-180	180	90
2MR-184	184	92
2MR-186	186	93
2MR-192	192	96
2MR-202	202	101
2MR-208	208	104
2MR-210	210	105
2MR-212	212	106
2MR-216	216	108
2MR-220	220	110
2MR-224	224	112
2MR-232	232	116
2MR-240	240	120
2MR-242	242	121
2MR-250	250	125
2MR-252	252	126
2MR-264	264	132
2MR-274	274	137
2MR-280	280	140
2MR-284	284	142
2MR-286	286	143
2MR-288	288	144
2MR-304	304	152
2MR-318	318	159
2MR-322	322	161
2MR-330	330	165
2MR-332	332	166
2MR-356	356	178
2MR-364	364	182
2MR-370	370	185
2MR-380	380	190
2MR-386	386	193
2MR-392	392	196
2MR-400	400	200

2MR Pitch: 2 mm

Pitch and length designation	Pitch length mm	Number of teeth
2MR-406	406	203
2MR-412	412	206
2MR-420	420	210
2MR-428	428	214
2MR-430	430	215
2MR-436	436	218
2MR-466	466	233
2MR-474	474	237
2MR-480	480	240
2MR-488	488	244
2MR-502	502	251
2MR-516	516	258
2MR-534	534	267
2MR-544	544	272
2MR-660	660	330
2MR-690	690	345
2MR-816	816	408
2MR-930	930	465
2MR-1032	1032	516
2MR-1164	1164	582
2MR-1386	1386	693
2MR-1700	1700	850
2MR-1830	1830	915

Available in widths of 3 mm, 6mm and 9 mm

3MR Pitch: 3 mm

Pitch and length designation	Pitch length mm	Number of teeth
3MR-105	105	35
3MR-120	120	40
3MR-135	135	45
3MR-144	144	48
3MR-150	150	50
3MR-165	165	55
3MR-180	180	60
3MR-186	186	62
3MR-192	192	64
3MR-195	195	65
3MR-204	204	68
3MR-210	210	70
3MR-216	216	72
3MR-225	225	75
3MR-231	231	77
3MR-240	240	80
3MR-243	243	81
3MR-246	246	82
3MR-252	252	84
3MR-255	255	85

3MR Pitch: 3 mm

Pitch and length designation	Pitch length mm	Number of teeth
3MR-267	267	89
3MR-270	270	90
3MR-276	276	92
3MR-285	285	95
3MR-288	288	96
3MR-294	294	98
3MR-300	300	100
3MR-309	309	103
3MR-312	312	104
3MR-324	324	108
3MR-330	330	110
3MR-339	339	113
3MR-357	357	119
3MR-360	360	120
3MR-363	363	121
3MR-375	375	125
3MR-384	384	128
3MR-390	390	130
3MR-393	393	131
3MR-408	408	136
3MR-420	420	140
3MR-426	426	142
3MR-450	450	150
3MR-456	456	152
3MR-480	480	160
3MR-483	483	161
3MR-489	489	163
3MR-495	495	165
3MR-501	501	167
3MR-510	510	170
3MR-513	513	171
3MR-522	522	174
3MR-537	537	179
3MR-540	540	180
3MR-552	552	184
3MR-564	564	188
3MR-570	570	190
3MR-582	582	194
3MR-588	588	196
3MR-600	600	200
3MR-630	630	210
3MR-657	657	219
3MR-750	750	250
3MR-840	840	280
3MR-849	849	283
3MR-897	897	299
3MR-1587	1587	529
3MR-1692	1692	564

Available in widths of 6 mm, 9mm and 15 mm

Preferred sizes are printed in bold.

Regd. Office : 5224, Nigam Market, G.B. Road, Delhi - 110006

Head Office : B-97/4, Naraina Industrial Area, Phase - I, New Delhi - 28 Ph.: 011 - 42709155 / 66 Fax : 011 - 45040209

Branch Office : Door No. 1/9, Rajamannar Salai, Vijayaraghavapuram, K.K. Nagar, Chennai - 600 093 Ph.: 044 - 42669808

Email : info@pbh.in

D-37

Website : www.pbh.in



INDUSTRIAL SYNCHRONOUS BELTS

POWERGRIP® GT BELT SIZES

5MR Pitch: 5 mm

Pitch and length designation	Pitch length mm	Number of teeth
5MR-200	200	40
5MR-225	225	45
5MR-250	250	50
5MR-265	265	53
5MR-275	275	55
5MR-280	280	56
5MR-285	285	57
5MR-300	300	60
5MR-325	325	65
5MR-330	330	66
5MR-340	340	68
5MR-350	350	70
5MR-360	360	72
5MR-375	375	75
5MR-400	400	80
5MR-410	410	82
5MR-415	415	83
5MR-425	425	85
5MR-450	450	90
5MR-460	460	92
5MR-475	475	95
5MR-490	490	98
5MR-500	500	100
5MR-510	510	102
5MR-525	525	105
5MR-530	530	106
5MR-540	540	108
5MR-550	550	110
5MR-600	600	120
5MR-625	625	125
5MR-650	650	130
5MR-665	665	133
5MR-700	700	140
5MR-750	750	150
5MR-775	775	155
5MR-800	800	160
5MR-850	850	170
5MR-860	860	172
5MR-900	900	180
5MR-950	950	190
5MR-980	980	196
5MR-1000	1000	200
5MR-1050	1050	210
5MR-1150	1150	230
5MR-2100	2100	420
5MR-2440	2440	488

Available in widths of 9 mm, 15 mm and 25 mm.

8MGT Pitch: 8 mm

Pitch and length designation	Pitch length mm	Number of teeth
8MGT-384	384	48
8MGT-480	480	60
8MGT-560	560	70
8MGT-600	600	75
8MGT-640	640	80
8MGT-720	720	90
8MGT-800	800	100
8MGT-840	840	105
8MGT-880	880	110
8MGT-920	920	115
8MGT-960	960	120
8MGT-1040	1040	130
8MGT-1064	1064	133
8MGT-1120	1120	140
8MGT-1160	1160	145
8MGT-1200	1200	150
8MGT-1280	1280	160
8MGT-1440	1440	180
8MGT-1512	1512	189
8MGT-1584	1584	198
8MGT-1600	1600	200
8MGT-1760	1760	220
8MGT-1800	1800	225
8MGT-2000	2000	250
8MGT-2400	2400	300
8MGT-2600	2600	325
8MGT-2800	2800	350
8MGT-3048	3048	381
8MGT-3280	3280	410
8MGT-3600	3600	450
8MGT-4400	4400	550

Available in widths of 20 mm, 30 mm 50 mm. and 85 mm.

14MGT Pitch: 14 mm

Pitch and length designation	Pitch length mm	Number of teeth
14MGT-966	966	69
14MGT-1190	1190	85
14MGT-1400	1400	100
14MGT-1610	1610	115
14MGT-1778	1778	127
14MGT-1890	1890	135
14MGT-2100	2100	150
14MGT-2310	2310	165
14MGT-2450	2450	175
14MGT-2590	2590	185
14MGT-2800	2800	200
14MGT-3150	3150	225
14MGT-3360	3360	240
14MGT-3500	3500	250
14MGT-3850	3850	275
14MGT-4326	4326	309
14MGT-4578	4578	327
14MGT-4956	4956	354
14MGT-5320	5320	380
14MGT-5740	5740	410
14MGT-6160	6160	440
14MGT-6860	6860	490

Available in widths of 40 mm, 55 mm, 85 mm, 115 mm and 170 mm.

Preferred sizes are printed in bold.

PRECISION BEARING HOUSE

MAXIMA TIMING PULLEY FOR HTD SERIES

How to Order

MTP **28 - 3M - 15 - 6F**

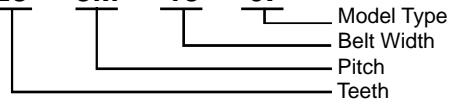

3.0 mm Pitch

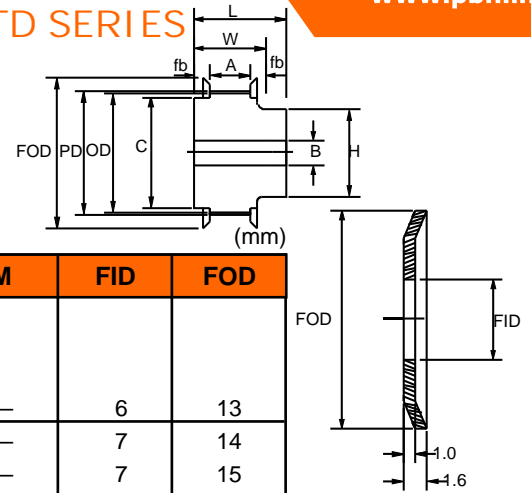

	PD	OD	C	B	H	M	FID	FOD
10	9.55	8.79	6	3	—	—	6	13
11	10.50	9.74	7	3	—	—	7	14
12	11.46	10.70	7	3	—	—	7	15
13	12.41	11.65	8	4	—	—	8	16
14	13.37	12.61	9	4	—	—	9	17
15	14.32	13.56	10	4	—	—	10	18
16	15.28	14.52	11	4	10	—	11	19
17	16.23	15.47	12	5	10	—	12	20
18	17.19	16.43	12	5	10	—	12	21
19	18.14	17.38	13	5	10	—	13	22
20	19.10	18.34	14	5	10	—	14	23
21	20.05	19.29	15	5	11	—	15	24
22	21.01	20.25	16	6	12	—	16	24
23	21.96	21.20	17	6	13	—	17	25
24	22.92	22.16	18	6	14	—	18	26
25	23.87	23.11	18	6	14	—	18	27
26	24.83	24.07	19	6	15	—	19	28
27	25.78	25.02	20	6	16	—	20	29
28	26.74	25.98	21	6	17	—	21	30
29	27.69	26.93	22	6	18	—	22	31
30	28.65	27.89	23	6	19	—	23	32
31	29.60	28.84	24	6	20	—	24	33
32	30.56	29.80	25	6	20	—	25	34
33	31.51	30.75	26	8	22	—	26	35
34	32.47	31.71	27	8	22	—	27	36
35	33.42	32.66	28	8	24	—	28	37
36	34.38	33.62	29	8	24	—	29	38
37	35.33	34.57	30	8	26	—	30	39
38	36.29	35.53	31	8	26	—	31	40
39	37.24	36.48	32	8	28	—	32	41
40	38.20	37.44	33	8	28	—	33	42
41	39.15	38.39	34	8	30	—	34	43
42	40.11	39.35	34	10	30	—	34	44
43	41.06	40.30	35	10	30	—	35	45
44	42.02	41.25	36	10	30	—	36	46
45	42.97	42.21	37	10	32	—	37	47
46	43.93	43.16	38	10	32	—	38	48
47	44.88	44.12	39	10	32	—	39	49
48	45.84	45.07	40	10	32	—	40	49
49	46.79	46.03	41	10	32	—	41	50
50	47.75	46.98	42	10	34	—	42	51
51	48.70	47.94	43	10	34	—	43	52
52	49.66	48.89	44	10	34	—	44	53
53	50.61	49.85	45	10	34	—	45	54
54	51.57	50.80	46	12	34	—	46	55
55	52.52	51.75	47	12	34	—	47	56

Regd. Office : 5224, Nigam Market, G.B. Road, Delhi - 110006

Head Office : B-97/4, Naraina Industrial Area, Phase - I, New Delhi - 28 Ph.: 011 - 42709155 / 66 Fax : 011 - 45040209

Branch Office : Door No. 1/9, Rajamannar Salai, Vijayaraghavapuram, K.K. Nagar, Chennai - 600 093 Ph.: 044 - 42669808

Email : info@pbh.in

D-39

Website : www.pbh.in

PRECISION BEARING HOUSE

MAXIMA TIMING PULLEY FOR HTD SERIES

How to Order

MTP **28 - 3M - 15 - 6F**

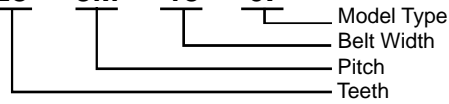

3.0 mm Pitch

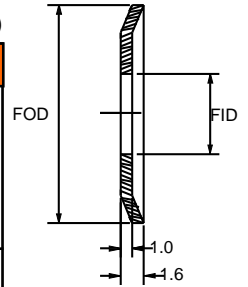
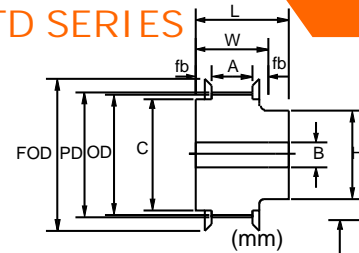

	PD	OD	C	B	H	M	FID	FOD
56	53.48	52.71	48	12	36	—	48	57
57	54.43	53.67	49	12	36	—	49	58
58	55.39	54.62	50	12	36	—	50	59
59	56.34	55.58	51	12	36	—	51	60
60	57.30	56.53	52	12	36	—	52	61
61	58.25	57.49	53	12	36	—	53	62
62	59.21	58.44	54	12	36	—	54	63
63	60.16	59.40	55	12	38	—	55	64
64	61.12	60.35	56	12	38	—	56	65
65	62.07	61.31	56	12	38	—	56	66
66	63.03	62.26	57	12	38	—	57	67
67	63.98	63.22	58	12	38	—	58	68
68	64.94	64.17	59	12	38	—	59	69
69	65.89	65.13	60	12	38	—	60	70
70	66.85	66.08	61	12	38	51	61	70
71	67.80	67.04	62	12	40	52	62	71
72	68.75	67.99	63	12	40	53	63	72
73	69.71	68.95	64	12	40	54	64	73
74	70.66	69.90	65	12	40	55	65	74
75	71.62	70.86	66	12	40	56	66	75
76	72.57	71.81	67	12	40	57	67	76
77	73.53	72.77	68	12	40	58	68	77
78	74.48	73.72	69	12	40	59	69	78
79	75.44	74.68	70	12	42	60	70	79
80	76.39	75.63	71	12	42	61	71	80
81	77.35	76.59	72	12	42	62	72	81
82	78.30	77.54	73	12	42	63	73	82
83	79.26	78.50	74	12	42	64	74	83
84	80.21	79.45	75	12	42	65	75	84
85	81.17	80.41	76	12	42	66	76	85
86	82.12	81.36	76	12	42	66	76	86
87	83.08	82.32	77	12	42	67	77	87
88	84.03	83.27	78	12	42	68	78	88
89	84.99	84.23	79	12	44	69	79	89
90	85.94	85.18	80	12	44	70	80	90
91	86.90	86.14	81	12	44	71	81	91
92	87.85	87.09	82	12	44	72	82	91
93	88.81	88.05	83	12	44	73	83	91
94	89.76	89.00	84	12	44	74	84	93
95	90.72	89.96	85	12	44	75	85	94
96	91.67	90.91	86	12	44	76	86	95
97	92.63	91.87	87	12	44	77	87	96
98	93.58	92.82	88	12	44	78	88	97
99	94.54	93.78	89	12	44	79	89	98
100	95.49	94.73	90	12	44	80	90	99
101	96.45	95.69	90	12	46	80	90	100
102	97.40	96.64	91	12	46	81	91	101
103	98.36	97.60	92	12	46	82	92	102
104	99.31	98.55	93	12	46	83	93	103
105	100.27	99.51	94	12	46	84	94	104

Regd. Office : 5224, Nigam Market, G.B. Road, Delhi - 110006

Head Office : B-97/4, Naraina Industrial Area, Phase - I, New Delhi - 28 Ph.: 011 - 42709155 / 66 Fax : 011 - 45040209

Branch Office : Door No. 1/9, Rajamannar Salai, Vijayaraghavapuram, K.K. Nagar, Chennai - 600 093 Ph.: 044 - 42669808

Email : info@pbh.in

D-40

Website : www.pbh.in

MAXIMA TIMING PULLEY

How to Order

MTP 28 - 3M - 15 - 6F

Model Type
Belt Width
Pitch
Teeth

3.0 mm Pitch

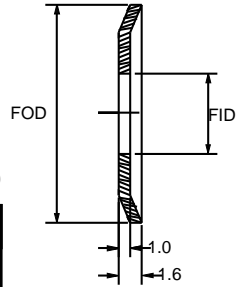
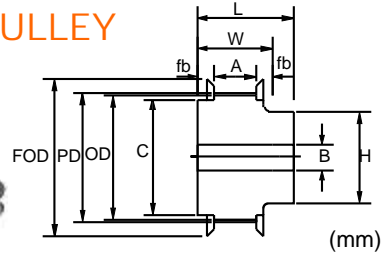

	PD	OD	C	B	H	M	FID	FOD
106	101.22	100.46	95	16	46	85	95	105
107	102.18	101.42	96	16	46	86	96	106
108	103.13	102.37	97	16	46	87	97	107
109	104.09	103.33	98	16	46	88	98	108
110	105.04	104.28	99	16	46	89	99	109
111	106.00	105.24	100	16	46	90	100	110
112	106.95	106.19	101	16	48	91	101	111
113	107.91	107.15	102	16	48	92	102	112
114	108.86	108.10	103	16	48	93	103	113
115	109.82	109.05	104	16	48	94	104	113
116	110.77	110.01	105	16	48	95	105	114
117	111.73	110.96	106	16	48	96	106	115
118	112.68	111.92	107	16	48	97	107	116
119	113.64	112.87	108	16	48	98	108	117
120	114.59	113.83	109	16	48	99	109	118
121	115.55	114.78	110	16	48	100	110	119
122	116.50	115.74	111	16	48	101	111	120
123	117.46	116.69	112	16	48	102	112	121
124	118.41	117.65	113	16	48	103	113	122
125	119.37	118.60	114	16	48	104	114	123
126	120.32	119.56	115	16	50	105	115	124
127	121.28	120.51	116	16	50	106	116	125
128	122.23	121.47	117	16	50	107	117	126
129	123.19	122.42	118	16	50	108	118	127
130	124.14	123.38	118	16	50	108	118	128
131	125.10	124.33	119	16	50	109	119	129
132	126.05	125.29	120	16	50	110	120	130
133	127.01	126.24	121	16	50	111	121	131
134	127.96	127.20	122	16	50	112	122	132
135	128.92	128.15	123	16	50	113	123	133
136	129.87	129.11	124	16	50	114	124	134
137	130.83	130.06	125	16	50	115	125	134
138	131.78	131.02	126	16	50	116	126	135
139	132.74	131.97	127	16	50	117	127	136
140	133.69	132.93	128	16	50	118	128	137
141	134.65	133.88	129	16	52	119	129	138
142	135.60	134.84	130	16	52	120	130	139
143	136.55	135.79	131	16	52	121	131	140
144	137.51	136.75	132	16	52	122	132	141
145	138.46	137.70	133	16	52	123	133	142
146	139.42	138.66	134	16	52	124	134	143
147	140.37	139.61	135	16	52	125	135	144
148	141.33	140.57	136	16	52	126	136	145
149	142.28	141.52	137	16	52	127	137	146
150	143.24	142.48	138	16	52	128	138	147

PRECISION BEARING HOUSE

MAXIMA TIMING PULLEY FOR HTD SERIES

How to Order

MTP **28 - 5M - 15 - 6F**

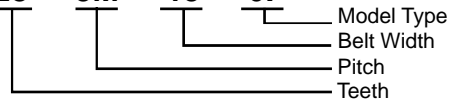

5.0 mm Pitch

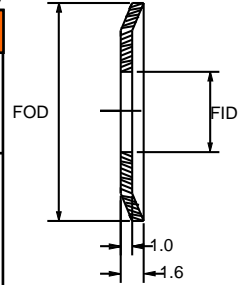
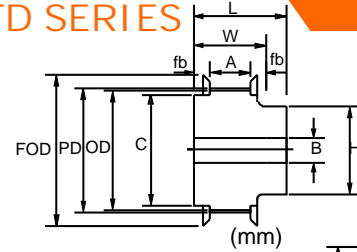

	PD	OD	C	B	H	M	FID	FOD
14	22.28	21.14	16	6	12	—	16	26
15	23.87	22.73	17	6	13	—	17	27
16	25.46	24.32	19	6	15	—	19	29
17	27.06	25.91	20	6	16	—	20	31
18	28.65	27.50	22	6	18	—	22	32
19	30.24	29.10	23	6	19	—	23	34
20	31.83	30.69	24	8	20	—	24	35
21	33.42	32.28	26	8	22	—	26	37
22	35.01	33.87	27	8	22	—	27	39
23	36.61	35.46	29	8	24	—	29	40
24	38.20	37.05	30	8	26	—	30	42
25	39.79	38.65	32	8	28	—	32	43
26	41.38	40.24	33	10	28	—	33	45
27	42.97	41.83	34	10	30	—	34	47
28	44.56	43.42	36	10	30	—	36	48
29	46.15	45.01	38	10	32	—	38	50
30	47.75	46.60	39	10	32	—	39	51
31	49.34	48.20	41	10	34	—	41	53
32	50.93	49.79	42	10	34	—	42	55
33	52.52	51.38	44	12	36	—	44	56
34	54.11	52.97	46	12	36	—	46	58
35	55.70	54.56	47	12	36	—	47	59
36	57.30	56.15	49	12	38	—	49	61
37	58.89	57.74	50	12	38	—	50	63
38	60.48	59.34	52	12	38	—	52	64
39	62.07	60.93	54	12	40	—	54	66
40	63.66	62.52	55	12	40	—	55	67
41	65.25	64.11	57	12	40	—	57	69
42	66.85	65.70	58	12	42	—	58	71
43	68.44	67.29	60	12	42	—	60	72
44	70.03	68.89	62	12	42	—	62	74
45	71.62	70.48	63	12	44	—	63	75
46	73.21	72.07	65	12	44	—	65	77
47	74.80	73.66	66	12	44	—	66	79
48	76.39	75.25	68	12	46	—	68	80
49	77.99	76.84	69	12	46	—	69	82
50	79.58	78.43	71	12	46	58	71	83
51	81.17	80.03	73	12	46	60	73	85
52	82.76	81.62	74	12	48	61	74	86
53	84.35	83.21	76	12	48	63	76	88
54	85.94	84.80	77	12	48	64	77	90
55	87.54	86.39	79	12	48	66	79	91
56	89.13	87.98	81	12	50	68	81	93
57	90.72	89.58	82	12	50	69	82	94
58	92.31	91.17	84	12	50	71	84	96
59	93.90	92.76	85	12	50	72	85	98
60	95.49	94.35	87	12	52	74	87	99

Regd. Office : 5224, Nigam Market, G.B. Road, Delhi - 110006

Head Office : B-97/4, Naraina Industrial Area, Phase - I, New Delhi - 28 Ph.: 011 - 42709155 / 66 Fax : 011 - 45040209

Branch Office : Door No. 1/9, Rajamannar Salai, Vijayaraghavapuram, K.K. Nagar, Chennai - 600 093 Ph.: 044 - 42669808

Email : info@pbh.in

D-42

Website : www.pbh.in

MAXIMA TIMING PULLEY FOR HTD SERIES

How to Order

MTP 28 - 5M - 15 - 6F

Model Type
Belt Width
Pitch
Teeth

5.0 mm Pitch

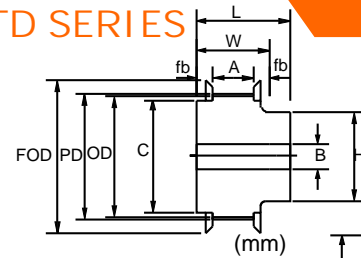

	PD	OD	C	B	H	M	FID	FOD
61	97.08	95.94	89	12	52	76	89	101
62	98.68	97.53	90	12	52	77	90	102
63	100.27	99.12	92	12	52	79	92	104
64	101.86	100.72	93	16	54	80	93	106
65	103.45	102.31	95	16	54	82	95	107
66	105.04	103.90	96	16	54	83	96	109
67	106.63	105.49	98	16	54	85	98	110
68	108.23	107.08	100	16	56	87	100	112
69	109.82	108.67	101	16	56	88	101	114
70	111.41	110.27	103	16	56	90	103	115
71	113.00	111.86	104	16	56	91	104	117
72	114.59	113.45	106	16	56	93	106	118
73	116.18	115.04	108	16	58	95	108	120
74	117.77	116.63	109	16	58	96	109	122
75	119.37	118.22	111	16	58	98	111	123
76	120.96	119.81	112	16	58	99	112	125
77	122.55	121.41	114	16	58	101	114	126
78	124.14	123.00	116	16	60	103	116	128
79	125.73	124.59	117	16	60	104	117	129
80	127.32	126.18	119	16	60	106	119	131
81	128.92	127.77	120	16	60	107	120	133
82	130.51	129.36	122	16	60	109	122	134
83	132.10	130.96	124	16	62	111	124	136
84	133.69	132.55	125	16	62	112	125	137
85	135.28	134.14	127	16	62	114	127	139
86	136.87	135.73	128	16	62	115	128	141
87	138.46	137.32	130	16	62	117	130	142
88	140.06	138.91	132	16	64	119	132	144
89	141.65	140.50	133	16	64	120	133	145
90	143.24	142.10	135	16	64	122	135	147
91	144.83	143.69	136	16	64	123	136	149
92	146.42	145.28	138	16	64	125	138	150
93	148.01	146.87	139	16	64	126	139	152
94	149.61	148.46	141	16	66	128	141	153
95	151.20	150.05	143	16	66	130	143	155
96	152.79	151.65	144	16	66	131	144	157
97	154.38	153.24	146	16	66	133	146	158
98	155.97	154.83	147	16	66	134	147	160
99	157.56	156.42	149	16	66	136	149	161
100	159.15	158.01	151	16	68	138	151	163
101	160.75	159.60	152	16	68	139	152	165
102	162.34	161.2	154	16	68	141	154	166
103	163.93	162.79	155	16	68	142	155	168
104	165.52	164.38	157	16	68	144	157	169
105	167.11	165.97	158	16	70	145	158	171
106	168.70	167.56	160	16	70	147	160	172
107	170.30	169.15	162	16	70	149	162	174
108	171.89	170.71	163	16	70	150	163	176
109	173.48	172.34	165	16	70	152	165	177
110	175.07	173.93	166	16	70	153	166	179

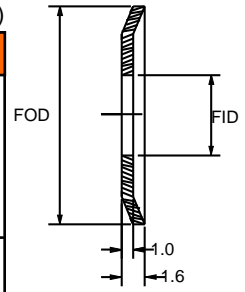

MAXIMA TIMING PULLEY FOR HTD SERIES

How to Order

MTP 28 - 5M - 15 - 6F

Model Type
Belt Width
Pitch
Teeth

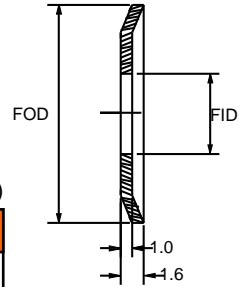
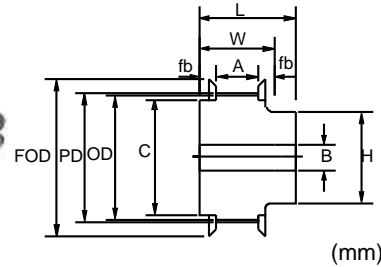

5.0 mm Pitch

	PD	OD	C	B	H	M	FID	FOD
111	176.66	175.52	168	16	70	155	168	180
112	178.25	177.11	170	16	70	157	170	182
113	179.85	178.70	171	16	72	158	171	184
114	181.44	180.29	173	16	72	160	173	185
115	183.03	181.89	174	16	72	161	174	187
116	184.62	183.48	176	16	72	163	176	188
117	186.21	185.07	178	16	72	165	178	190
118	187.80	186.66	179	16	72	166	179	192
119	189.39	188.25	181	16	72	168	181	193
120	190.99	189.84	182	16	74	169	182	195
121	192.58	191.43	184	16	74	171	184	196
122	194.17	193.03	186	16	74	173	186	198
123	195.76	194.62	187	16	74	174	187	200
124	197.35	196.21	189	16	74	176	189	201
125	198.94	197.80	190	16	74	177	190	203
126	200.54	199.39	192	16	74	179	192	204
127	202.13	200.98	193	20	76	180	193	206
128	203.72	202.58	195	20	76	182	195	207
129	205.31	204.17	197	20	76	184	197	209
130	206.90	205.76	198	20	76	185	198	211
131	208.49	207.35	200	20	76	187	200	212
132	210.08	208.94	201	20	76	188	201	214
133	211.68	210.53	203	20	76	190	203	215
134	213.27	212.12	205	20	76	192	205	217
135	214.86	213.72	206	20	78	193	206	219
136	216.45	215.31	208	20	78	195	208	220
137	218.04	216.90	209	20	78	196	209	222
138	219.63	218.49	211	20	78	198	211	223
139	221.23	220.08	213	20	78	200	213	225
140	222.82	221.67	214	20	78	201	214	227
141	224.41	223.27	216	20	78	203	216	228
142	226.00	224.86	217	20	78	204	217	230
143	227.59	226.45	219	20	80	206	219	231
144	229.18	228.04	221	20	80	208	221	233
145	230.77	229.63	222	20	80	209	222	235
146	232.37	231.22	224	20	80	211	224	236
147	233.96	232.81	225	20	80	212	225	238
148	235.55	234.41	227	20	80	214	227	239
149	237.14	236.00	229	20	80	216	229	241
150	238.73	237.59	230	20	80	217	230	242

PRECISION BEARING HOUSE

MAXIMA TIMING PULLEY FOR HTD SERIES

How to Order

MTP **28 - 8M - 15 - 6F**

Model Type
Belt Width
Pitch
Teeth

8.0 mm Pitch

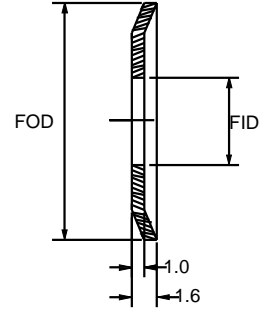
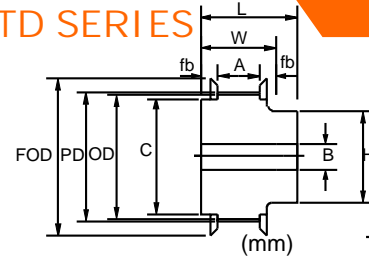

	PD	OD	C	B	H	M	FID	FOD
20	50.93	49.56	40	16	36	—	40	62
21	53.48	52.10	40	16	36	—	40	62
22	56.02	54.65	45	16	40	—	45	64
23	58.57	57.20	47	16	42	—	47	67
24	61.12	59.74	50	16	44	—	50	70
25	63.66	62.29	52	16	46	—	52	72
26	66.21	64.84	54	16	48	—	54	75
27	68.75	67.38	57	16	50	—	57	77
28	71.30	69.96	59	16	52	—	59	80
29	73.85	72.48	62	16	54	—	62	82
30	76.39	75.02	64	16	56	—	64	85
31	78.94	77.57	67	16	58	—	67	88
32	81.49	80.12	69	20	60	—	69	90
33	84.03	82.66	71	20	62	—	71	93
34	86.58	85.21	74	20	64	—	74	95
35	89.13	87.75	76	20	66	—	76	98
36	91.67	90.30	79	20	68	—	79	100
37	94.22	92.85	81	20	70	—	81	103
38	96.77	95.39	84	20	72	—	84	105
39	99.31	97.94	86	20	74	—	86	108
40	101.86	100.49	89	20	74	—	89	110
41	104.41	103.03	92	20	76	—	92	113
42	106.95	105.58	94	20	76	—	94	116
43	109.50	108.13	97	20	78	—	97	118
44	112.05	110.67	99	20	78	—	99	121
45	114.59	113.22	102	20	78	—	102	123
46	117.14	115.77	104	20	80	—	104	126
47	119.68	118.31	107	20	80	—	107	128
48	122.23	120.86	109	20	80	—	109	131
49	124.78	123.41	112	20	82	—	112	133
50	127.32	125.95	114	20	82	94	114	136
51	129.87	128.50	117	20	82	97	117	139
52	132.42	131.04	119	20	84	99	119	141
53	134.96	133.59	122	20	84	102	122	143
54	137.51	136.14	125	20	84	105	125	146
55	140.06	138.68	127	20	86	107	127	149
56	142.60	141.23	130	20	86	110	130	151
57	145.15	143.78	132	20	86	112	132	154
58	147.70	146.32	135	20	88	115	135	156
59	150.24	148.87	137	20	88	117	137	159
60	152.79	151.42	140	30	88	120	140	161
61	155.34	153.96	142	30	90	122	142	164
62	157.88	156.51	145	30	90	125	145	166
63	160.43	159.06	147	30	90	127	147	169
64	162.97	161.60	150	30	92	130	150	172
65	165.52	164.15	153	30	92	133	153	174

Regd. Office : 5224, Nigam Market, G.B. Road, Delhi - 110006

Head Office : B-97/4, Naraina Industrial Area, Phase - I, New Delhi - 28 Ph.: 011 - 42709155 / 66 Fax : 011 - 45040209

Branch Office : Door No. 1/9, Rajamannar Salai, Vijayaraghavapuram, K.K. Nagar, Chennai - 600 093 Ph.: 044 - 42669808

Email : info@pbh.in

D-45

Website : www.pbh.in

PRECISION BEARING HOUSE

MAXIMA TIMING PULLEY FOR HTD SERIES

How to Order

MTP **28 - 8M - 15 - 6F**

Model Type
Belt Width
Pitch
Teeth

8.0 mm Pitch

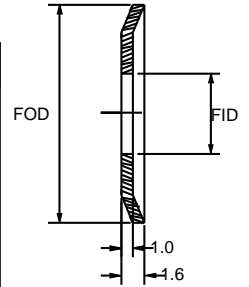
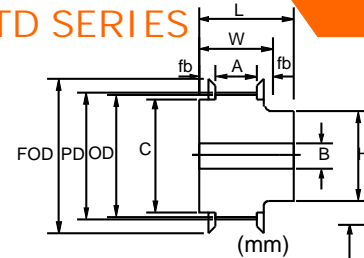

	PD	OD	C	B	H	M	FID	FOD
66	168.07	166.70	155	30	92	135	155	177
67	170.61	169.24	158	30	94	138	158	179
68	173.16	171.79	160	30	94	140	160	182
69	175.71	174.34	163	30	94	143	163	184
70	178.25	176.88	165	30	94	145	165	187
71	180.80	179.43	168	30	94	148	168	190
72	183.35	181.97	171	30	94	151	171	192
73	185.89	184.52	173	30	96	153	173	195
74	188.44	187.07	175	30	96	155	175	197
75	190.99	189.61	178	30	96	158	178	200
76	193.53	192.16	180	30	96	160	180	202
77	196.08	194.71	183	30	96	163	183	205
78	198.63	197.25	186	30	96	166	186	207
79	201.17	199.80	188	30	98	168	188	210
80	203.72	202.35	191	30	98	171	191	212
81	206.26	204.89	193	30	98	173	193	215
82	208.81	207.44	196	30	98	176	196	218
83	211.36	209.99	198	30	98	178	198	220
84	213.90	212.53	201	30	98	181	201	223
85	216.45	215.08	203	30	100	183	203	225
86	219.00	217.63	206	30	100	186	206	228
87	221.54	220.17	208	30	100	188	208	230
88	224.09	222.75	211	30	100	191	211	233
89	226.64	225.56	214	30	100	194	214	235
90	229.18	227.81	216	30	100	196	216	238
91	231.73	230.36	219	30	102	199	219	240
92	234.28	232.90	221	30	102	201	221	243
93	236.82	235.45	224	30	102	204	224	246
94	239.37	238.00	226	30	102	206	226	248
95	241.92	240.54	229	30	102	209	229	251
96	244.46	243.09	231	30	102	211	231	253
97	247.01	245.64	234	30	104	214	234	256
98	249.55	248.18	236	30	104	216	236	258
99	252.10	250.73	239	40	104	219	239	261
100	254.65	253.28	242	40	104	222	242	263
101	257.19	255.82	244	40	104	224	244	266
102	259.74	258.37	247	40	104	227	247	268
103	262.29	260.92	249	40	106	229	249	271
104	264.83	263.46	252	40	106	232	252	274
105	267.38	266.01	254	40	106	234	254	276
106	269.93	268.55	257	40	106	237	257	279
107	272.47	271.10	259	40	106	239	259	281
108	275.02	273.65	262	40	106	242	262	284
109	277.57	276.19	264	40	108	244	264	286
110	280.11	278.74	267	40	108	247	267	289
111	282.66	281.29	270	40	108	250	270	291
112	285.21	283.83	272	40	108	252	272	294
113	287.75	283.38	275	40	108	255	275	296
114	290.30	288.93	277	40	108	257	277	299
115	292.85	291.47	280	40	110	260	280	302

Regd. Office : 5224, Nigam Market, G.B. Road, Delhi - 110006

Head Office : B-97/4, Naraina Industrial Area, Phase - I, New Delhi - 28 Ph.: 011 - 42709155 / 66 Fax : 011 - 45040209

Branch Office : Door No. 1/9, Rajamannar Salai, Vijayaraghavapuram, K.K. Nagar, Chennai - 600 093 Ph.: 044 - 42669808

Email : info@pbh.in

D-46

Website : www.pbh.in

MAXIMA TIMING PULLEY FOR HTD SERIES

How to Order

MTP 28 - 8M - 15 - 6F

Model Type
Belt Width
Pitch
Teeth



8.0 mm Pitch (mm)

	PD	OD	C	B	H	M	FID	FOD
116	295.39	294.02	282	40	110	262	282	304
117	297.94	296.57	285	40	110	265	285	307
118	300.48	299.11	287	40	110	267	287	309
119	303.03	301.66	290	50	110	270	290	312
120	305.58	304.21	292	50	110	272	292	314
121	308.12	306.75	295	50	112	275	295	317
122	310.67	309.30	298	50	112	278	298	319
123	313.22	311.84	300	50	112	280	300	322
124	315.76	314.39	303	50	112	283	303	324
125	318.31	316.94	305	50	112	285	305	327
126	320.86	319.48	308	50	112	288	308	330
127	323.40	322.03	310	50	114	290	310	332
128	325.95	324.58	313	50	114	293	313	335
129	328.50	327.12	315	50	114	295	315	337
130	331.04	329.67	318	50	114	298	318	340
131	333.59	332.22	320	50	114	300	320	342
132	336.14	334.76	323	50	114	303	323	345
133	338.68	337.31	326	50	116	306	326	348
134	341.26	339.86	328	50	116	308	328	350
135	343.77	342.40	331	50	116	311	331	353
136	346.32	344.95	333	50	116	313	333	355
137	348.87	347.50	336	50	116	316	336	358
138	351.41	350.04	338	50	116	318	338	360
139	353.96	352.59	341	50	118	321	341	363
140	356.51	355.14	343	50	118	323	343	365
141	359.05	357.68	346	50	118	326	346	368
142	361.6	360.23	348	50	118	328	348	370
143	364.15	362.77	351	50	118	331	351	373
144	366.69	365.32	354	50	118	334	354	376
145	369.24	367.87	356	50	120	336	356	378
146	371.79	370.41	359	50	120	339	359	381
147	374.33	372.96	361	50	120	341	361	383
148	376.88	375.51	364	50	120	344	364	386
149	379.43	378.05	366	50	120	346	366	388
150	381.97	380.60	369	50	120	349	369	391

SOLUTIONS FOR INDUSTRIAL AUTOMATION

- Linear Guides
- Ball Screw & Lead Screw
- Ball Screw Support Unit
- Coupling
- Linear Motion Bearing
- Shafts (Hardened & Ground)
- Pillow Block Bearing Unit
- Precision Lock Nut & Power Lock
- Timing Belt & Pulley
- Actuators, X-Y Tables
- Maxima Work Table & Conveyor
- Stepper Motors, Drivers
- AC Servo Motors & Drive
- Motion & Controllers
- Rotary Indexing Tables
- Cable Drag Chain (Robochain)
- Aluminium Profile & Accessories
- Leveling Foot Mount & Autocaster



Maxima Conveyor



Maxima Work Table